



AN ISO 9001 CERTIFIED COMPANY

nippon instruments (india) Pvt. Ltd.



Manufacturers of : **Process Control Instruments and Sensors**

301-302B, Alankar Indl. Est., Off Aarey Rd., Near Virwani, Goregaon (E), Mumbai 400 063. India
 Tel : 2875 5867 Fax : 2875 2289 E-mail : nippontech@vsnl.com

nippon's ELECTRONIC DELAY TIMERS 400R

FEATURES



nippon 400R Series is high performance RC timer series. Timers are available in on-delay, off-delay & equal on-off(repeat cycle)modes. These timers find application in panel building, small delays, repeat operations etc.

nippon 400R timers are housed in ABS molded din rail enclosures. The economical cost offers excellent value for money.



FEATURES

- Electronic time delay in single range & multi range
- 1 c/o or 2 c/o relay output models
- Modular design
- Process indications
 Green LED for relay status
 Red LED for mains on
- Wide operating voltage ranges
- Front adjustable knob for delay time
- Available in various sizes
- Economical & reliable

TIMING DIAGRAM

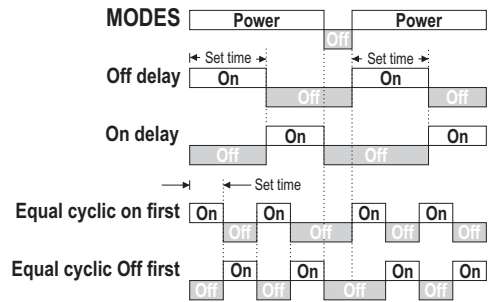

SPECIFICATIONS

Timing Range	: 3,6,10,20,30,60 sec. /3,6,10...min.
Control output	: 1c/o or 2c/o relay output 7A @250vac.
Setting accuracy	: ± 5% of full scale.
Repeat accuracy	: ± 0.5% of full scale.
Timing modes	: Fixed & selectable on-delay/off-delay/cyclic equal on-off
Annunciation	: Power on, relay on L.E.D.'s
Power supply	: 240V,110V, 24V,12V AC@50Hz / 24V,12V DC factory set
AC power consumption	: Approx. 6 watts
Operating temperature	: 10°C to 55°C
Mounting & dimensions	: Available in Dinrail & Panel

Note : In multi range models selector switches available for range and control selection.

Terminal Numbers

MODEL		400R-P8	400R-P11	400R-T	400R-S	400R-B
Single range RC timer	multi range RC timer	8 way plug-in type terminals (48*48)	11 way plug-in type terminals (48*48)	12 way screw type terminals (48*48)	8 way screw type terminals (small din rail)	12 way screw type terminals (big din rail)
Power	Power	2,7	2,7	1,2	A1,A2	1,2
A] 1 st c/o	A] 1 st c/o	1,3,4	1,3,4	7,8,9	15,16,18	12,11,10
B] 2 nd c/o	B] 2 nd c/o	7,6,5	11,9,8	10,11,12	25,26,28	9,8,7

nippon's ELECTRONIC STAR-DELTA TIMERS 400SD

FEATURES



nippon make Star-Delta Timer 400SD is designed to provide a simple, economical and reliable operation for Star-Delta induction motor starters.

FEATURES

- 1c/o relay output model
- Modular design
- Simple Star-Delta Starter Wiring
- Process indications
Green LED for delta operation
Red LED for star operation
- Front adjustable knob for star time
- Wide operating voltage ranges
- Available in various sizes
- Economical & reliable



TIMING DIAGRAM

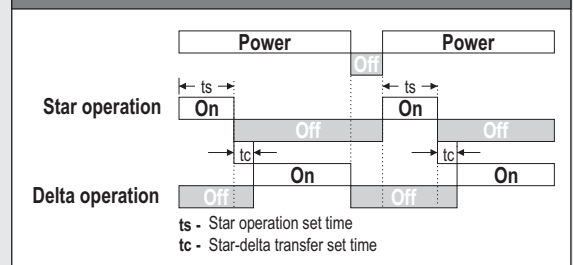

SPECIFICATIONS

Fixed transition time (star to delta)	: 50 milliseconds
Adjustable (star) time delay	: 1 to 30/60 seconds control output
Control output	: 1c/o, 5A@250VAC, 2 Relays
Setting accuracy	: ± 5% of full scale
Repeat accuracy	: ± 0.5% of full scale
Annunciation	: Green LED for delta operation Red LED for star operation
Rated operating voltages	: 240V,110V, 24V,12V AC@50Hz / 24V,12V DC factory set
AC power consumption	: Approx. 6 watts
Operating temperature	: 10°C to 55°C
Mounting & dimensions	: Available in Dinrail & Panel

Note : 400SD-B is available with higher current ratings

MODEL	Terminal Numbers				
	400SD-P8	400SD-P11	400SD-T	400SD-S	400SD-B
Star-delta timer	8 way plug-in type terminals (48*48)	11 way plug-in type terminals (48*48)	12 way screw type terminals (48*48)	8 way screw type terminals (small din rail)	12 way screw type terminals (big din rail)
Power	2,7	2,7	1,2	A1,A2	1,2
Star relay	1,3,4	1,3,4	7,8,9	15,16,18	12,11,10
Delta relay	7,6,5	11,9,8	10,11,12	25,26,28	9,8,7

**Panel mounting enclosures : 48x48x95mm [WxHxD]
screw type 12 way terminal :**

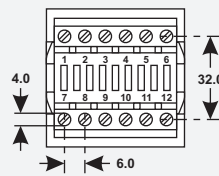
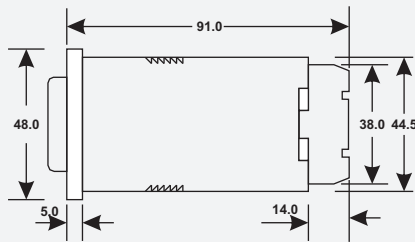
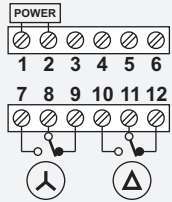

Panel cut-out

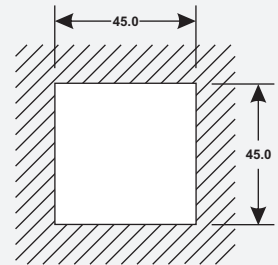

Plug in type 11 way terminal:

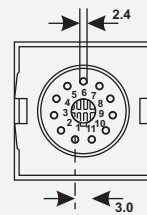
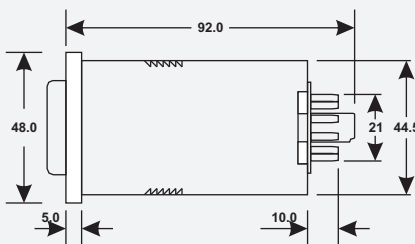
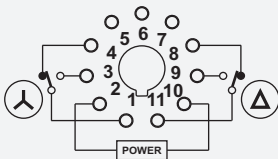

Plug in type 8 way terminal:

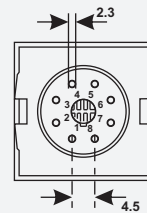
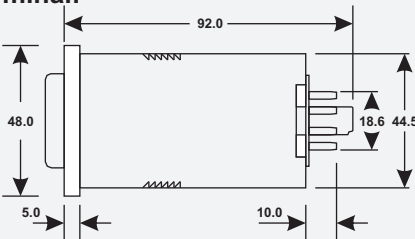
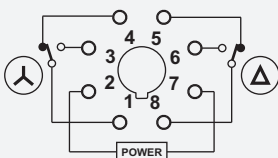

**Din rail screw mounting enclosures:
Screw type 8 way terminal : 22.5x75x102mm [WxHxD]**

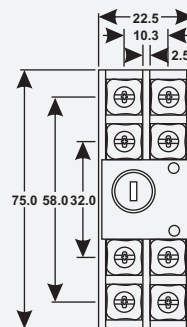
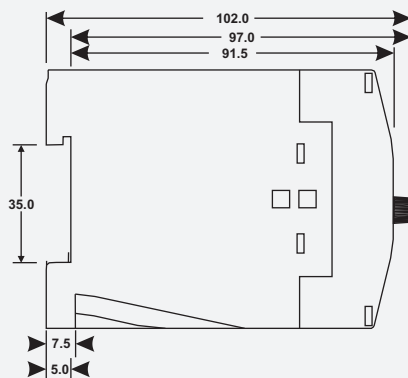
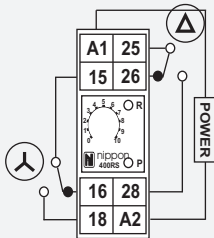

Mounting diagrams

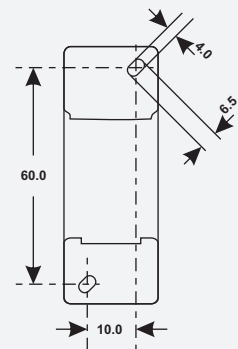

Screw type 12 way terminal: 61x71x110.5mm [WxHxD]

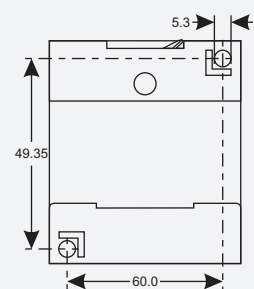
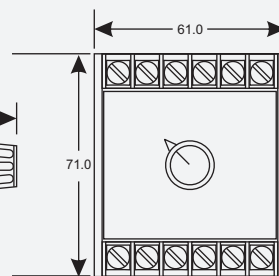
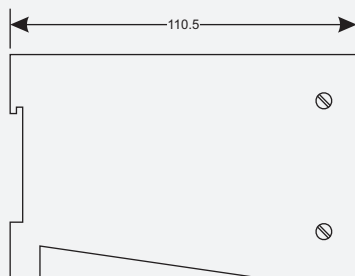
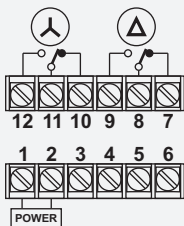

NOTE : single range, multi range delay timers & star-delta electronic timers are available in above enclosures.

OTHER RANGE OF TIMERS



LOW COST PRESETTABLE



**DIGITAL PRESETTABLE
72 X 72**



TIME TOTALISER



**DIGITAL PRESETTABLE
96 X 96**



CYCLIC WITH DISPLAY



LOW COST CYCLIC



MICROTIME 72 X 72



AUGAR TIMER

nippon's SALES OFFICES

SURAT : Rd. No. 6, Udhna, Surat, Gujarat.
Tel : (0261) 2278422 / 5544180
TeleFax : (0261) 2279423
Mobile : 9824111306
E-mail : darsh20@satyam.net.in

Pune : Telefax : (020) 24376245
Delhi : (011) 26903568 / 26347099
Durg : (0788) 3105117 / 9827111400
Hyderabad : (040) 27173724 / 14
Allahabad : (0532) 2613746

Chennai : 09382744155 Telefax : 22292383
Gwalior : (0751) 2231951 Fax : 2344889
Goa : (0832) 2312710 / 2317399
Kolkata : 09831057357 / 09831152530
Jamshedpur : (065) 72420672 / 09431131694